



INVITATION TO BID

ATTENTION: This is not an order. Read all instructions, terms and conditions carefully.

INVITATION NO.: KCT-01178	RETURN ORIGINAL COPY OF BID TO:
Issue Date: April 9, 2019	KCTCS PROCUREMENT TO PAYMENT DEPT ATTN: BID # KCT-01178 300 NORTH MAIN STREET VERSAILLES, KY 40383
Method of Award: Best Value	
Procurement Analyst: Sharon Bullard	
Email: sharon.bullard@kctcs.edu	
Bids are invited on the following: FIRE RESCUE TRAILER	
IMPORTANT: SEALED BIDS MUST BE RECEIVED BY 04/30/2019 by 4:00 PM Eastern Daylight Time	

1. Sealed Bids for furnishing the following will be received by the Procurement to Payment Department, KCTCS, Versailles, Kentucky, until the date and time stated above or in Addenda. ***Bid documents must be submitted in a sealed envelope identified with the Invitation to Bid number and the opening/return date on the face of the envelope. FACSIMILE BIDS WILL NOT BE ACCEPTED.***
2. Please quote your single best net price on each item, unless a discount from list price is requested, delivered to the address specified, all transportation charges prepaid. Price shall include delivery to the department address shown on this Invitation. Submission of two (2) bids may result in disqualification of both bids.
3. Bids must be firm. Those containing escalator clauses cannot be accepted, unless provided for in Special Conditions. To receive consideration, bids must be made on this form and signed in full. Prices must be based on stated units and extended. Delivery guarantee must be shown. Bids will be rejected unless filled out in ink or on typewriter and signed in ink.
4. The KCTCS Sales Tax Exemption Number is A-20633. Certificate will be provided upon request. Do Not Quote Sales Tax. (...continued on following page.....)

SIGNATURE REQUIRED: This bid cannot be considered valid unless signed and dated by an authorized agent of the bidder. Type or print the information requested in the spaces provided.
ALL BIDS ARE TO BE "TRANSPORTATION CHARGES PREPAID, F.O.B. DESTINATION"

THIS AREA MUST BE COMPLETED

DELIVERY TIME: (Days after receipt of order)	NAME OF COMPANY	PHONE:
BID FIRM THROUGH:	NO. & STREET	FAX:
PAYMENT TERMS: Net 30 days Must Accept PO	CITY, STATE & ZIP CODE	
F.O.B. DESTINATION	SIGNATURE	DATE:
Email		
FEDERAL ID NUMBER (EIN):	TYPED OR PRINTED NAME	

In submitting this bid, it is expressly agreed that, upon proper acceptance by Kentucky Community and Technical College System of any or all items bid, a contract shall thereby be created with respect to the items accepted.

BIDS MAY ALSO BE VIEWED AT OUR WEBSITE: [http://systemoffice.kctcs.edu/Vendor Information](http://systemoffice.kctcs.edu/Vendor%20Information).
All bids and contracts are subject to General Terms and Conditions of KCTCS. You may download/print a copy of these from our website or you may request a copy be mailed to you by contacting the Issuing Officer in this solicitation.

AUTHENTICATION OF BID AND STATEMENT OF NON-COLLUSION AND NON-CONFLICT OF INTEREST

I hereby swear (or affirm) under the penalty for false swearing as provided by KRS 523.040:

1. That I am the bidder (if the bidder is an individual), a partner, (if the bidder is a partnership), or an officer or employee of the bidding corporation having authority to sign on its behalf (if the bidder is a corporation);
2. That the attached bid has been arrived at by the bidder independently and has been submitted without collusion with, and without any agreement, understanding or planned common course of action with, any other vendor of materials, supplies, equipment or services described in the Invitation to Bid, designed to limit independent bidding or competition;
3. That the contents of the bid or bids have not been communicated by the bidder or its employees or agents to any person not an employee or agent of the bidder or its surety on any bond furnished with the bid or bids and will not be communicated to any such person prior to the official opening of the bid or bids;
4. That the bidder is legally entitled to enter into contracts with KCTCS and is not in violation of any prohibited conflict of interest, including those prohibited by the provisions of KRS 164.390, 61.096, and 42.990, and;
5. That I have fully informed myself regarding the accuracy of the statement made above.

NOTICE

1. Any agreement or collusion among bidders or prospective bidders which restrains, tends to restrain, or is reasonably calculated to restrain competition by agreement to bid at a fixed price or to refrain from bidding, or otherwise, is prohibited.
2. Any person who violates any provisions of KRS 45A.325 shall be guilty of a felony and shall be punished by a fine of not less than five thousand dollars nor more than ten thousand dollars, or be imprisoned not less than one year nor more than five years, or both such fine and imprisonment. Any firm, corporation, or association which violates any of the provisions of KRS 45A.325 shall, upon conviction, be fined not less than ten thousand dollars nor more than twenty thousand dollars.

SWORN STATEMENT OF COMPLIANCE WITH CAMPAIGN FINANCE LAWS

In accordance with KRS45A.110(2), the undersigned hereby swears under penalty of perjury that he/she has not knowingly violated any provision of the campaign finance laws of the Commonwealth of Kentucky and that the award of a contract to a bidder will not violate any provision of the campaign finance laws of the Commonwealth of Kentucky.

CONTRACTOR REPORT OF PRIOR VIOLATIONS OF KRS CHAPTERS 136, 139, 141, 337, 338, 341 & 342

The contractor by signing and submitting a bid on this invitation agrees as required by 45A.485 to submit final determinations of any violations of the provisions of KRS Chapters 136, 139, 141, 337, 338, 341 and 342 that have occurred in the previous five (5) years prior to the award of a contract and agrees to remain in continuous compliance with the provisions of the statutes during the duration of any contract that may be established. Final determinations of violations of these statutes must be provided to KCTCS by the successful contractor prior to the award of a contract.

CERTIFICATION OF NON-SEGREGATED FACILITIES

The contractor, by submitting a bid on this Invitation, certifies that he/she is in compliance with the Code of Federal Regulations, No. 41 CFR 60-1.8(b), that prohibits maintaining segregated facilities.

INSTRUCTIONS TO BIDDERS:

Bidder's response on the following items must include full identification of the item(s) proposed, and be accompanied by descriptive literature, etc., to enable the purchaser to evaluate qualifications of the item(s) proposed as equal to those specified. ALL ALTERNATE QUOTATIONS MUST BE ACCOMPANIED BY COMPLETE LITERATURE AND SPECIFICATIONS TO EVALUATE ALTERNATE QUOTE AS EQUAL TO THAT SPECIFIED. FAILURE TO PROVIDE SUFFICIENT INFORMATION WILL BE CAUSE FOR REJECTION OF THE BID.

When a Bidder proposes to furnish the exact item specified, he shall cite, beside the item, or use the Mfg. & Model No. Proposed blank that follows the line item as follows:

1. If bidding the manufacturer and model number specified in this Invitation, write in "AS SPECIFIED".
2. If bidding an alternate model, identify by manufacturer's number and model.
3. If bidding a private label model, identify as private label and show stock number.

ALL BIDS ARE TO BE "TRANSPORTATION CHARGES PREPAID, F.O.B. DESTINATION"

METHOD OF AWARD

Unless otherwise specified, it is the intent of KCTCS to award this Invitation to Bid on a Best Value per Group basis. In the event no satisfactory bids are received, we reserve the right to award on a group award basis.

1. Introduction

1.1. Purpose of Procurement

You are invited to bid on the following **FIRE RESCUE TRAILER** for the Kentucky Community & Technical College System (KCTCS), Fire Commission.

1.2. Overview of the Invitation to Bid Process

The objective of the Invitation to Bid is to select one or more qualified suppliers to provide the goods and/or services outlined in this Invitation to Bid to KCTCS. This Invitation to Bid process will be conducted to gather and evaluate responses from suppliers for potential award. All qualified suppliers are invited to participate by submitting responses, as further defined below. After evaluating all suppliers' responses received prior to the opening date of this Bid, the results of the Bid will be posted at the following link (under "Solicitation Results"):

https://systemoffice.kctcs.edu/vendor_information/opportunities_to_bid/index.aspx

Offerors should not assume personal notice will be given regarding the solicitation results.

1.3. Schedule of Events

The schedule of events set out herein represents KCTCS's best estimate of the schedule that will be followed. However, delays to the procurement process may occur which may necessitate adjustments to the proposed schedule. If a component of this schedule, such as the close date, is delayed, the rest of the schedule may be shifted as appropriate. After the opening of the Invitation to Bid, KCTCS reserves the right to adjust the remainder of the proposed dates, including the dates for evaluation and award on an as needed basis with or without notice.

If applicable, suppliers are encouraged to visit the specified KCTCS location(s) prior to submitting a bid to inspect the conditions at the site. If the Bid indicates a site visit is being conducted, any suppliers

Description	Date	Time
Release of Invitation to Bid	04/09/2019	
Deadline for written questions sent via email to the Issuing Officer referenced	04/22/2019	4:00 p.m. ET
Bid Opening Date and Time	04/30/2019	4:00 p.m. ET

1.4. Official Issuing Officer (Buyer)

sharon.bullard@kctcs.edu

2. Instructions to Suppliers

By submitting a response to the Invitation to Bid, the supplier is acknowledging that the supplier:

1. Has read the information and instructions,
2. Agrees to comply with the information and instructions contained herein.

2.1. General Information and Instructions

2.1.1. Restrictions on Communicating with Staff

From the issue date of this Invitation to Bid until the final award is announced (or the Invitation to Bid is officially cancelled), the Issuing Officer named herein, shall be the point of contact throughout the solicitation process. KCTCS reserves the right to reject the response of any supplier violating this provision. This does not preclude suppliers who presently hold contracts with KCTCS from communicating with KCTCS individuals regarding existing contracts only, and/or to schedule a site visit.

2.1.2. Submitting Questions

Any explanation desired by a supplier regarding the meaning or interpretation of the solicitation, specifications, etc., must be requested in writing to the Issuing Officer identified in Section 1.6. Questions will not be addressed via telephone. Oral explanations or instructions given before the award of the contract will not be binding. In the event any

item, requirement, term or condition of this Invitation to Bid is not clear, or is not according to regulation, it shall be the sole responsibility of the interested prospective supplier to inquire with the Issuing Officer.

All suppliers must submit questions by the deadline identified in the Schedule of Events for submitting questions. Suppliers are cautioned that KCTCS may or may not elect to entertain late questions or questions submitted by any other method than as directed by this section. **Deadline for questions is April 19, 2019.**

2.1.3. Attending Bidders Conference

The Bidders conference or any other information session (if indicated in the schedule of events) will be held at the offices referred to in Section 1.5 "Schedule of Events". In the event the conference has been identified as mandatory, then a representative of the supplier must attend the conference in its entirety to be considered eligible for contract award. The supplier is strongly encouraged to allow ample travel time to ensure arrival to the location prior to the beginning of any mandatory conference. KCTCS reserves the right to consider any representative arriving late to be "not in attendance." Therefore, all suppliers are strongly encouraged to arrive early to allow for unexpected travel contingencies.

2.1.4. Oral Discussions

Potential bidders should clearly understand that any verbal representations made or assumed to be made during any oral discussions held between representatives of potential bidders and any KCTCS employee are not binding on KCTCS.

2.1.5. Right to Request Additional Information

Prior to an award, KCTCS must be assured that the selected supplier has all of the resources to successfully perform under the contract. This may include, but is not limited to, adequate number of personnel with required skills, availability of appropriate equipment in sufficient quantity to meet the on-going needs of KCTCS, financial resources sufficient to complete performance under the contract, and experience in similar endeavors. If, during the evaluation process, KCTCS is unable to assure itself of the supplier's ability to perform, if awarded, KCTCS has the option of requesting from the supplier any information deemed necessary to determine the supplier's responsibility.

2.1.6. Failing to Comply with Submission Instructions

Responses received after the identified due date and time or submitted by any other means than those expressly permitted by the Invitation to Bid will not be considered. Responses must be complete in all respects, as required in each section of this Invitation to Bid.

2.1.7. Amend and/or Cancel the Invitation to Bid

KCTCS reserves the right to amend this Invitation to Bid prior to the opening date and time. Amendments will be made in writing and posted as one or more addenda to the KCTCS website. Each supplier is individually responsible for reviewing addenda and any other posted documents and making any necessary or appropriate changes and/or additions to the supplier's response. All suppliers are encouraged to frequently check the KCTCS website for additional information at the following link: https://systemoffice.kctcs.edu/vendor_information/opportunities_to_bid/index.aspx

KCTCS reserves the right to cancel this Invitation to Bid at any time if it is in the best interest of KCTCS to do so.

2.1.8. Costs for Preparing Responses

Each response should be prepared simply and economically, avoiding the use of elaborate promotional materials beyond those sufficient to provide a complete presentation. The cost for developing the response and participating in the procurement process is the sole responsibility of the supplier. KCTCS will not provide reimbursement for such costs.

2.1.9. ADA Guidelines

When applicable (e.g. webpages) the Contractor's products and services will be in compliance with current Americans with Disability Act (ADA) requirements including the applicable current ADA Standards for Accessible Design, Section 508 of the Rehabilitation Act of 1973, as amended (29 U.S.C. 794d), Section 255 of the Communications Act, as amended and applicable regs.

2.2. Submittal Instructions

Listed below are key action items related to this Invitation to Bid. The Schedule of Events in Section 1.3 identifies the dates and time for these key action items. This portion of the Bid provides instructions regarding the process for reviewing the Bid, preparing a response to the Bid and submitting a response to the Bid.

2.2.1. Invitation to Bid Released

The release of this Bid is formally communicated through the posting of this Bid on the KCTCS website, which is accessible online as follows: https://systemoffice.kctcs.edu/vendor_information/opportunities_to_bid/index.aspx

2.2.2. Invitation to Bid Review

The Invitation to Bid consists of the following:

1. This document, and
2. Any and all documents provided by KCTCS as attachments to the Bid or links contained within the Bid or its attached documents.

Please carefully review all information contained in the Bid, including all documents available as attachments or available through links. Any difficulty accessing the Invitation to Bid or opening provided links or documents should be reported immediately to the Issuing Officer (See Section 1.4).

2.2.3. Submitting a Response

Sealed Bids will be received in the offices of the Procurement to Payment department at the following address:

Kentucky Community and Technical College System
Attn: KCT-01178
300 North Main Street
Versailles, Kentucky 40383

All Bids will be time stamped by the KCTCS Procurement to Payment department upon receipt. Bids received after the due date and time will not be evaluated. Bids that are faxed or emailed will be rejected.

3. General Business Requirements

This section contains general business requirements. By submitting a response, the supplier is certifying its agreement to comply with all of the identified requirements of this section and that all costs for complying with these general business requirements are included in the supplier's submitted pricing.

3.1. Authorization to do Business in Kentucky

The successful supplier affirms that it is properly authorized under the laws of the Commonwealth of Kentucky to conduct business in this state and will remain in good standing to do business in the Commonwealth of Kentucky for the duration of any contract awarded. The Supplier shall maintain certification of authority to conduct business in the Commonwealth of Kentucky during the term of this Contract. Such registration is obtained from the Secretary of State, who will also provide the certification thereof.

The successful supplier affirms that it is properly authorized under the laws of the Commonwealth of Kentucky to conduct business in this state and will remain in good standing to do business in the Commonwealth of Kentucky for the duration of any contract awarded. The Supplier shall maintain certification of authority to conduct business in the Commonwealth of Kentucky during the term of this Contract. Such registration is obtained from the Secretary of State, who will also provide the certification thereof.

3.2. Personal Information Security

To the extent Supplier receives Personal Information as defined by and in accordance with Kentucky's Personal Information Security and Breach Investigation Procedures and Practices Act, KRS 61.931, 61.932 and 61.933 (the "Act"), Supplier shall secure and protect the Personal Information by, without limitation: (i) complying with all requirements applicable to non-affiliated third parties set forth in the Act; (ii) utilizing security and breach investigation procedures that are appropriate to the nature of the Personal Information disclosed, at least as stringent as KCTCS' and reasonably designed to protect the Personal Information from unauthorized access, use, modification, disclosure, manipulation, or destruction; (iii) notifying KCTCS of a security breach relating to Personal Information in the possession of Supplier or its agents or sub suppliers within seventy-two (72) hours of discovery of an actual or suspected breach unless the exception set forth in KRS 61.932(2)(b)2 applies and Supplier abides by the requirements set forth in that exception; (iv) cooperating with KCTCS in complying with the response, mitigation, correction, investigation, and notification requirements of the Act, (v) paying all costs of notification, investigation and mitigation in the

event of a security breach of Personal Information suffered by Supplier; and (vi) at KCTCS' discretion and direction, handling all administrative functions associated with notification, investigation and mitigation.

3.3. Access to Record

The Contractor, as defined in KRS 45A.030 (9) agrees that the contracting agency, the Finance and Administration Cabinet, the Auditor of Public Accounts, and the Legislative Research Commission, or their duly authorized representatives, shall have access to any books, documents, papers, records, or other evidence, which are directly pertinent to this contract for the purpose of financial audit or program review. Records and other prequalification information confidentially disclosed as part of the bid process shall not be deemed as directly pertinent to the contract and shall be exempt from disclosure as provided in KRS 61.878(1)(c). The contractor also recognizes that any books, documents, papers, records, or other evidence, received during a financial audit or program review shall be subject to the Kentucky Open Records Act, KRS 61.870 to 61.884.

3.4. Public Information

KCTCS is a governmental entity subject to disclosure obligations under KRS 61.870 through 61.884 or successor legislation. Information clearly marked "confidential" under this agreement shall be treated as information identified by the offeror as confidential, trade secret, commercially sensitive information and shall not be disclosed except as provided by law.

3.5. Governing Law

The contract shall be construed according to the laws of the Commonwealth of Kentucky. Any legal proceedings against KCTCS regarding this Invitation to Bid or any resultant contract shall be brought in Commonwealth of Kentucky administrative or judicial forums.

3.6. Standard Insurance and Bonding Requirements

Prior to the beginning of the contract, the contractor will furnish to the Procurement to Payment Department Certificates of Insurance that show it has and will maintain all insurance protection (including products liability insurance) at the contractor's expense.

Minimum liability coverage must be:

Public Liability -Comprehensive General Owners, Landlords and Tenants

Bodily Injury Liability

Each Person \$1,000,000

Each Occurrence \$1,000,000

Property Damage Liability \$1,000,000

Products Liability

Each Person \$1,000,000

Each Occurrence \$1,000,000

Automobile Liability

Bodily Injury

Each Person \$1,000,000

Each Occurrence \$1,000,000

Personal Injury Liability

Each Person \$1,000,000

Property Damage Liability \$1,000,000

Worker's Compensation Statutory

Employers Liability \$ 500,000

The Kentucky Community and Technical College System must be named as an additional insured in the policy for Comprehensive General Liability. In the event of failure by the contractor to maintain, in force, insurance coverage acceptable to KCTCS, KCTCS will have the right to terminate this Agreement immediately upon written notice to the contractor. Copies of the Insurance Certificates are to be furnished to the KCTCS Procurement to Payment Department. Modification of this requirement must be requested in writing with supporting statements, prior to the time of the bid submission.

Within ten (10) business days of award, the awarded supplier must procure the required insurance and provide the KCTCS with two (2) Certificates of Insurance. Please see section 3.1 for more details.

4. Form of Proposal Factors

The Invitation to Bid contains the requirements and related services that the supplier must meet. KCTCS has determined that it is best to define its own needs, desired operating objectives, and desired operating environment. KCTCS will not tailor these needs to fit a particular solution a supplier may have available; rather, the suppliers shall propose to meet KCTCS’s needs as defined in this Invitation to Bid.

4.1. Alternates

Unless otherwise specified, references to brand name or trade name/mark products are intended to be descriptive, but not restrictive, and are used to indicate the quality and characteristics of products that may be offered. Other products may be considered for award if such products are clearly identified and are determined by KCTCS to meet its needs in all respects. Each supplier’s response must indicate the brand name and model or series number of the product offered and include such specifications, catalog pages, or other data that will provide an adequate basis for determining the quality and functional capabilities of the product offered.

4.2. Equipment

Attached is the list of products required. All equipment proposed and delivered by the successful supplier must be "New and Current Model(s)". No used/refurbished equipment or demonstrator models will be acceptable. All serial number tags, FCC approval numbers, model numbers, etc. must be affixed on each piece of equipment at the time of delivery. Equipment will be inspected and rejected if these numbers are not affixed or have been altered.

4.2.1. Equipment Listing Requirements

All equipment and assemblies of equipment offered in response to this Invitation to Bid shall be in full compliance with all current applicable standards established by Federal, State, and Local governments, including, but not limited to OSHA, NFPA 70, NFPA 79, the Kentucky Building Code and all applicable references noted therein.

The equipment must also be listed and labeled by a nationally recognized testing laboratory (NRTL) or certified by field evaluation and labeled by a third party nationally recognized testing laboratory (NRTL) acceptable to the authority having jurisdiction in Kentucky to certify compliance with applicable codes and safety requirements. If a listing does not exist or third party certification cannot be provided for said equipment, the services of a Professional Engineer licensed in the Commonwealth of Kentucky may also be procured by the supplier to certify that the equipment has been constructed in accordance with NFPA 79 and UL 508A standards and their references. **All costs associated with required listings or certifications shall be included in the bid price.** Each piece of equipment or assembly of equipment offered in response to this bid shall either be listed and labeled or certified and labeled prior to shipment by the successful supplier.

All equipment and assemblies of equipment offered in response to this Invitation to Bid shall be in full compliance with the above referenced listing or certification requirements. If a listing does not exist or third party certification cannot be provided for said equipment, the services of a Professional Engineer licensed in the Commonwealth of Kentucky may also procured by the supplier to certify that the equipment has been constructed in accordance with NFPA 79 and UL 508A standards and their references.

4.3. Supplier References

Suppliers must submit with their bid at least three (3) references where services have been provided that are similar to the scope of work of this solicitation. Information provided must include persons to contact with addresses, email addresses, the size of the institution/business served, and other pertinent information, which would aid in the determination of an experienced Supplier. KCTCS reserves the right to request additional information to determine the responsibility of the apparent successful Supplier relative to its ability to comply with the terms and conditions of this Invitation to Bid. Please write legibly.

Name/Address and contact email/Size: _____

Name/Address and contact email/Size: _____

Name/Address and contact email/Size: _____

5. Costs/Pricing

5.1. General Pricing Rules

Each supplier is required to submit pricing as part of its response. By submitting a response, the supplier agrees that it has read, understood, and will abide by the following instructions/rules:

1. The submitted pricing must include all costs of performing pursuant to the resulting PO; and
2. The supplier is required to provide net prices. In the event there is discrepancy between a supplier's unit price and extended price, the unit price shall govern;
3. All product deliveries will be F.O.B. destination and all shipping charges must be included in the quoted cost; and
4. Responses containing prepayment and/or progress payment requirements may be determined non-responsive; and
5. Responses requiring payment from KCTCS in less than thirty (30) days will be considered non-responsive; and
6. KCTCS is exempt from certain taxes and no provision for such taxes should be included in the supplier's response.

5.2 Cost Structure

The KCTCS's intent is to structure the cost format in order to facilitate comparison among all suppliers and foster competition to obtain the best market pricing. Consequently, KCTCS requires that each supplier's cost be structured as directed in the Invitation to Bid. Additional alternative cost structures will not be considered. Each supplier is hereby advised that failure to comply with the Invitation to Bid instructions, submission of an incomplete offer, or submission of an offer in a different format than the one requested may result in the rejection of the supplier's response.

6. Award

6.1. Method

KCTCS intends to award a contract to the responsive and responsible supplier(s), based on Best Value, who meets the Terms, Conditions, and Specifications of this Invitation to Bid.

Best Value - Ranking Approach: with the ranking approach, price is one of the measurable criteria components of the solicitation. The measurable criteria are added together to determine the contractor's total score. The contractor with the highest score has the highest ranking. Award is made to the contractor with the highest ranking. If there is only one best value response to the solicitation, the evaluation process may be waived and award may be made to the only responsive, responsible contractor.

6.2. Measurable Criteria

TOTAL POINTS 100 Points

Each Supplier is responsible for submitting all relevant, factual and correct information with their offer to enable the evaluator(s) to afford each Supplier the maximum score based on the available data submitted by the Supplier. SUPPLIER SHALL ENTER UNIT PRICE AND TOTAL PRICE ON THE BID SHEET. If adequate space is not available, the Supplier must attach additional information that clearly cross-references the appropriate location in the solicitation (i.e. page number, paragraph, subject, etc.).

Price: 90 Points

Delivery: 10 Points

Price (90 Points)

The bidder with the lowest Price receives the maximum score. The bidder with the next lowest Price receives points by dividing the lowest Price by the next lowest price and multiplying that percentage by the available points. For example, 100 points is allocated to the lowest Price criteria for this procurement, Bidder "A" bids \$3.00 as the lowest bidder and receives the maximum 100 points ($\$3.00 / \$3.00 = 1.00 \times 100 = 100$). Assume Bidder "B" is the next lowest bidder at \$4.00, then "B" receives 75 points ($\$3.00 / \$4.00 = .75 \times 100 = 75$).

Delivery (10 Points)

The supplier with the best delivery time receives the maximum score. The supplier with the next best delivery time receives points by dividing the lowest time by the next lowest time and multiplying that percentage by the available points. For example, 10 points is allocated to the lowest time criteria for this procurement, Supplier "A" with the best delivery time bids 45 days and receives the maximum 10 points ($45/45 = 1.00 \times 10 = 10$). Assume Supplier "B" has the next best delivery time supplier at 60 days, then "B" receives 7.50 points ($45/60 = .75 \times 10 = 7.50$).

Best Value scoring is subject to Reciprocal Preference for Kentucky resident suppliers.

6.3. Breaking Tie Bids

Tie low bids on the purchase of commodities may be broken in the following order if price and delivery are equal.

1. Time discount.
2. KRS 45A.494 Reciprocal preference to be given by public agencies to resident bidders -- List of states -- Administrative regulations. (4) If a procurement determination results in a tie between a resident bidder and a nonresident bidder, preference shall be given to the resident bidder.
3. Supplier who has performed satisfactorily in the past over supplier who has not previously served KCTCS or who has not performed in satisfactory manner.
4. Flip of coin, witnessed by at least two KCTCS personnel.

The bid file shall be documented listing one or more of the above listed factors.

6.4. Selection

KCTCS reserves the right to: (a) reject any and all responses, in whole or in part; (b) request clarifications from suppliers; and (c) take any other action as permitted by law.

Any contract award resulting from the Invitation to Bid will be made to the lowest, responsive and responsible supplier meeting all specifications.

Any award(s) resulting from the Invitation to Bid will be made to the lowest, responsive and responsible supplier(s) meeting all specifications. KCTCS reserves the right to select one or more suppliers for award and to award all items to one or more suppliers, individual line items to one or more suppliers, or subcategories of products/services to one or more suppliers when to do so is in the best interests of KCTCS.

6.5. Consideration

To be considered for award of a contract, the contractor must be in good standing with KCTCS System Office regarding past performance. In order to be considered for an award, Supplier cannot have had a contract with KCTCS that was not renewed or terminated early (unless at the Supplier's request) for performance reasons within the previous twelve (12) months (from the bid opening date on this bid event).

6.6. Kentucky Reciprocal Preference Laws

In accordance with KRS 45A.490 to 45A.494, Kentucky Resident Bidder Status, a resident Offeror of the Commonwealth of Kentucky shall be given a preference against a nonresident Offeror. In evaluating proposals, KCTCS will apply a reciprocal preference against an Offeror submitting a proposal from a state that grants residency preference equal to the preference given by the state of the nonresident Offeror. Residency and nonresidency shall be defined in accordance with KRS 45A.494(2) and 45A.494(3), respectively. Any Offeror claiming Kentucky residency status must submit with its bid/proposal a notarized affidavit (Resident Bidder Claim Form,) with supporting documentation affirming that it meets the criteria as set for in the above referenced statute. Further, in accordance with KRS 45A.465 and 45A.470, any bidder wishing to claim qualified bidder status must complete and include an Affidavit for Qualified Bidder Status with their response. In evaluating responses, KCTCS will apply preference in accordance with KRS 45A.470. An Affidavit for Qualified Bidder Status forms is available from KCTCS Procurement to Payment, upon request.

6.7. Public Award Notice

The solicitation results will be posted at the link below. No supplier should assume personal notice of the solicitation results will be provided by KCTCS.

https://systemoffice.kctcs.edu/vendor_information/opportunities_to_bid/index.aspx

7. Contract Terms and Conditions

The contract that KCTCS expects to award as a result of this Invitation to Bid will be based upon the Bid, the successful supplier's final response as accepted by KCTCS and the contract terms and conditions, which terms and conditions can be downloaded from:

https://systemoffice.kctcs.edu/vendor_information/general_terms_and_conditions.aspx.

The supplier will be responsible for compliance with all applicable Federal, State and Local Laws, Regulations and Mandates. The supplier shall ensure that all of its employees comply with these Federal, State and Local Laws, Regulations and Mandates.

7.1. Supplier's Terms & Conditions

Responses submitted that include any additional supplier terms or conditions or contain terms and conditions in conflict with the Statutes of the Commonwealth of Kentucky may be deemed non-responsive. Suppliers must refrain from imposing conditions that would modify the terms and conditions of the solicitation or limit the supplier's liability to KCTCS on the contract awarded on the basis of such Invitation. Question regarding the terms and conditions of this Invitation to Bid shall be submitted in writing to the Issuing Officer prior to the deadline for submitting written questions as defined by the Section 1.5., Schedule of Events.

8. List of Invitation to Bid Attachments

The following documents make up this Invitation to Bid. Any difficulty locating or accessing the following documents should be immediately reported to the Issuing Officer.

- A. KCTCS Invitation to Bid (this document)

9. Specifications

Confined Space Rescue Trailer

The Confined Space Rescue Trailer is utilized to train individuals in ways to rescue victims from confined spaces and to train individuals in compliance to the OSHA Standard 29 CFR 1910.146.

The trailer will be fully equipped with ropes, rescue equipment, safety equipment, harnesses, and tripod system provided by the purchaser. Additionally, the trailer is equipped with an electronic winch to aid in the loading and unloading of the tubes carried on top of the trailer to create a "complex" rescue scenario for the students training with this prop. This trailer has vertical and horizontal spaces available to execute rescues with air quality monitoring, rope rescue, rescue tripod, basic to advanced rigging, ventilation, and lock/out tag out equipment.

The trailer has two vertical openings on the top of the trailer and each opening has a steel door that allows for safety when working on the trailer. There is also horizontal opening on the side of the trailer to be utilized for training. The trailer also has extra tubes that can be attached to the trailer to further the learning experience.

Must meet or exceed the following specifications for the Fire Rescue Trailer:
(See attached specifications)

KENTUCKY FIRE COMMISSION
118 James Court
Lexington, Kentucky 40505

CONFINED SPACE TRAINING PROP PLAN

Confined Space Trailer Prop Specifications/Modifications

1. Aluminum Deck for all floor areas
2. Delete 2 Lowe's boxes from right side of trailer (Sheet 3) and replace with custom matching cabinet but be 14 inches deep.
3. Delete tubular storage (sheet 3) and replace with custom matching cabinet being approximately 3 feet wide, 4 feet 6 inches high, and 7 foot 10 inches deep with doors on both ends. Cabinets shall have 2 shelves and 2 dividers.
4. OSHA approved toe plates and hand rails on perimeter of trailer.
5. Hand rails on top of trailer (Sheet 6) do not need to fold in on this trailer this will include hand rails A-E on sheet 6.
6. Need 6 Anchor Points approximately 6 inches where indicated on Sheet 8 Revised/Attached
7. Delete Table and Lowes Job Box. (Sheet 8)
8. Mount Davit to left front corner. Davit will be provided.
9. Hinged 5 foot section of hand rail to open on top for loading of extra tubes.
10. Rear entry hole on top of trailer shall be 24 inch manhole with hinged poly cover. (Sheet 8)

Construction requested to be completed by June 15th.

Pre-construction meeting will be held with Coordinator Marc Henderson.

Kentucky Fire Commission Confined Space Prop Specifications

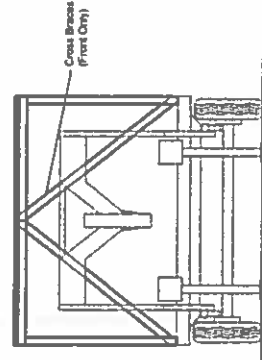
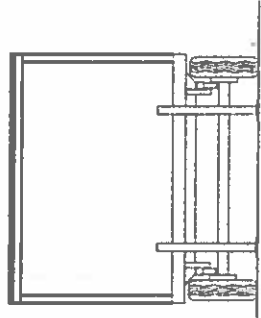
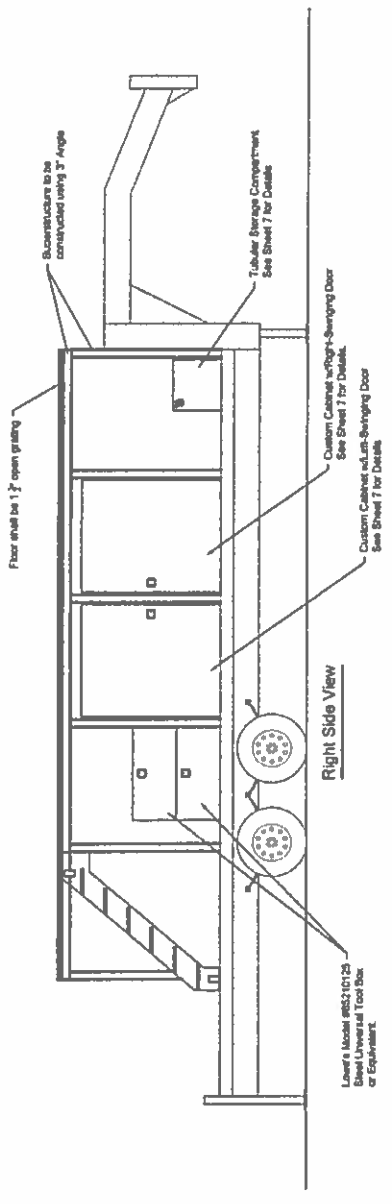
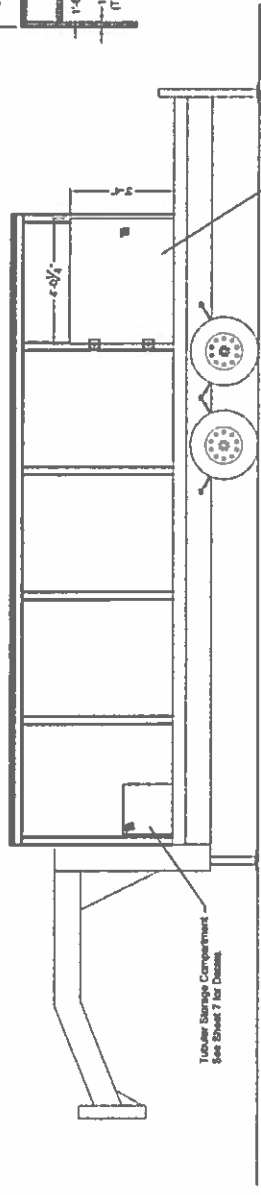
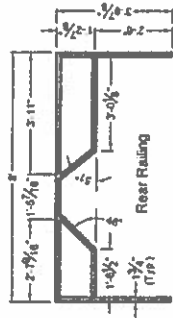
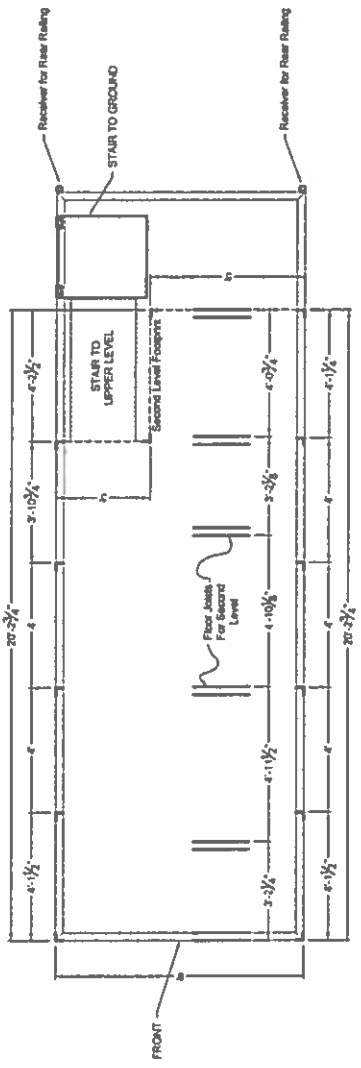

KENTUCKY FIRE COMMISSION
118 James Court
Lexington, Kentucky 40505

CONFINED SPACE PROP

**POSTS LAYOUT
and
FEATURES**

Date Aug. 2016 Pr. C.H.M. Sheet 3 of 9

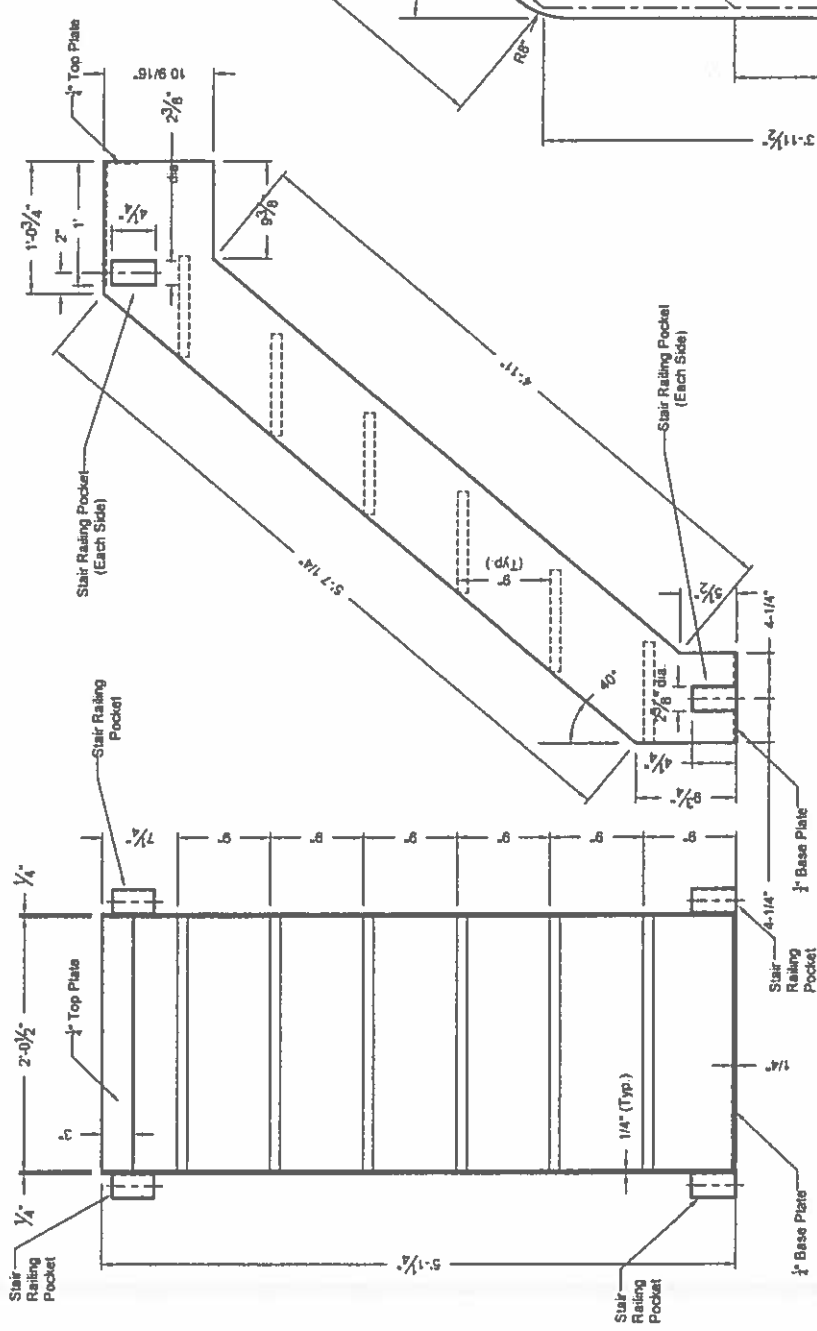
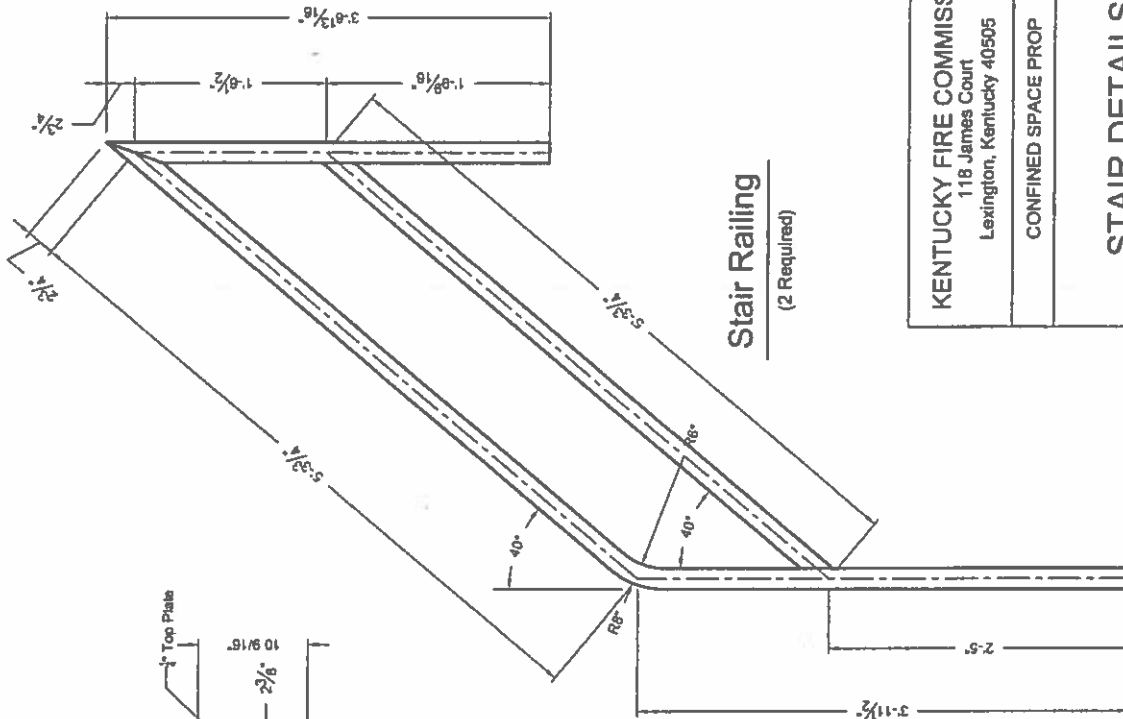

Side View

Front View

Stair Details
(Main Floor to Second Level)

KENTUCKY FIRE COMMISSION 118 James Court Lexington, Kentucky 40505	
CONFINED SPACE PROP	
STAIR DETAILS (Main Floor to Second Level)	
Date: Aug. 2018	Pr: C.H.M.
Sheet: 4 of 9	

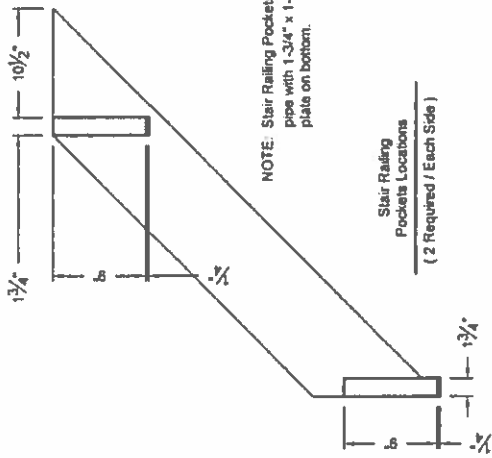

NOTE: Stair Railing Pockets are 1-3/4" dia. pipe with 1-3/4" x 1-3/4" x 1/2" stop plate on bottom.

Stair Railing Pockets Locations
(2 Required / Each Side)

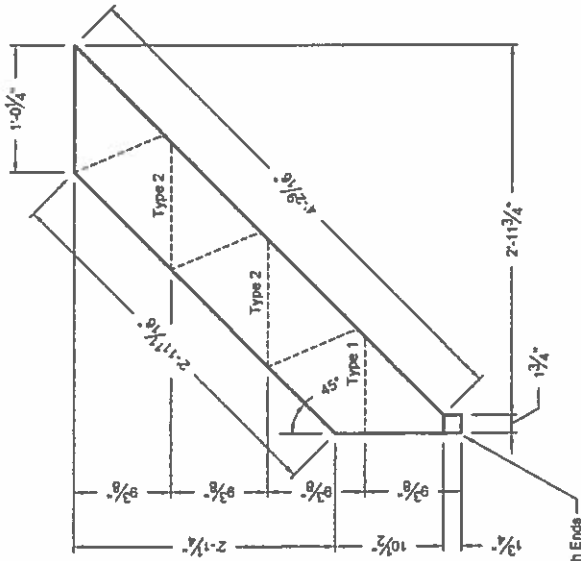
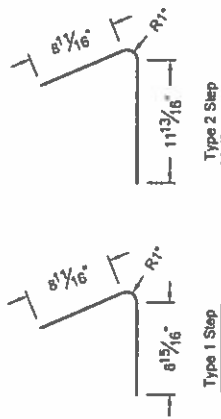
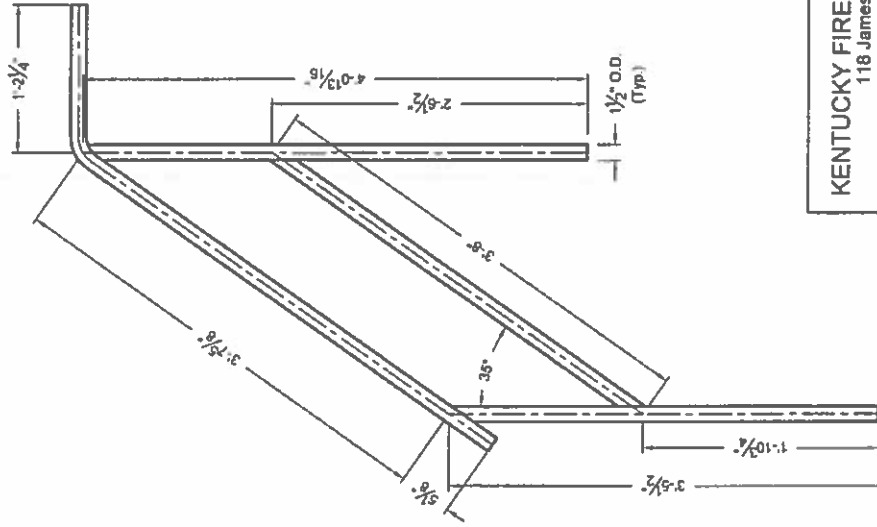

1 3/4" Square Tube Closed On Both Ends

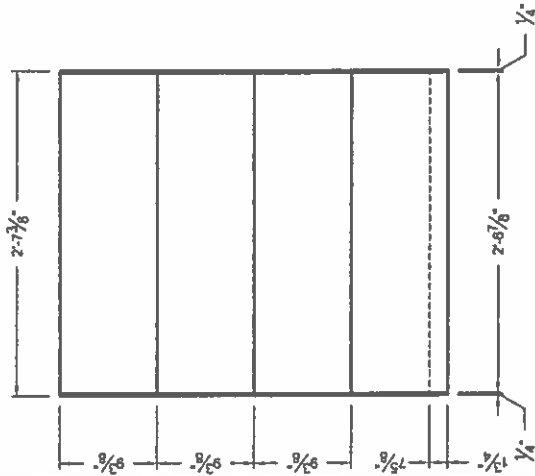

Front View

Side View

Stair Railing
(2 Required)

Stair Details
(Ground to Main Floor)

KENTUCKY FIRE COMMISSION
118 James Court
Lexington, Kentucky 40505

CONFINED SPACE PROP

STAIR DETAILS
(Ground to Main Floor)

Date Aug. 2016 By C.H.M. Sheet 5 of 9

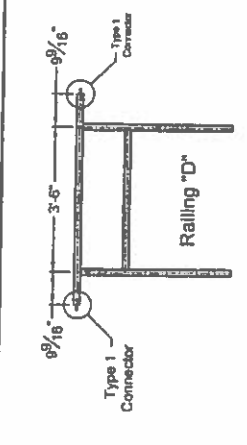
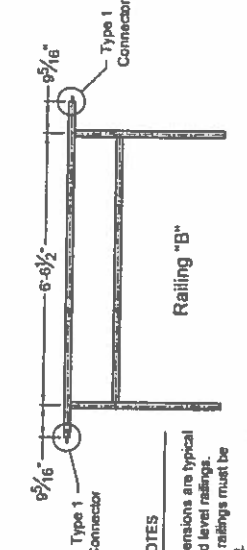
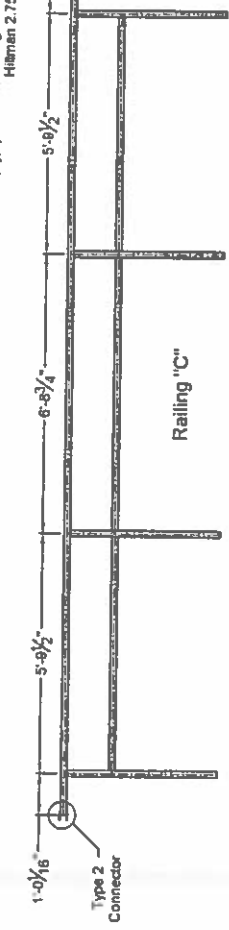
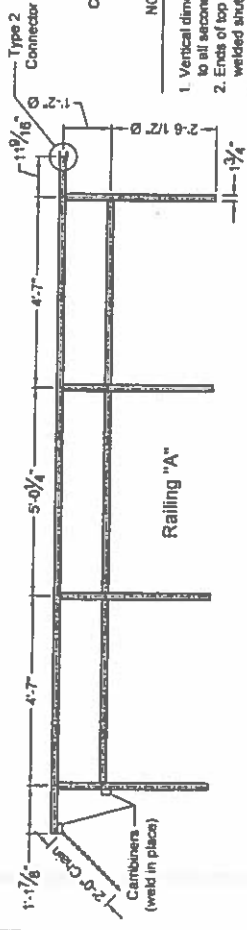

- NOTES**
1. Vertical dimensions are typical to all second level railings.
 2. Ends of top railings must be welded shut.
 3. Railings shall be connected using a Model #832654 Hillman 2.75-in Round Wire Lock Pin or equivalent.

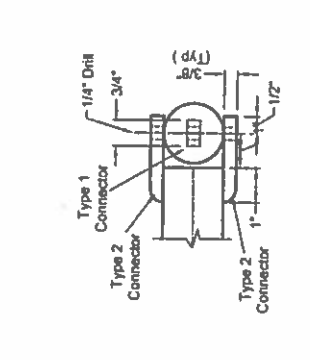
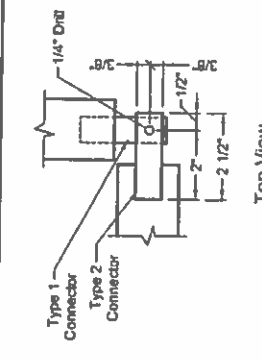
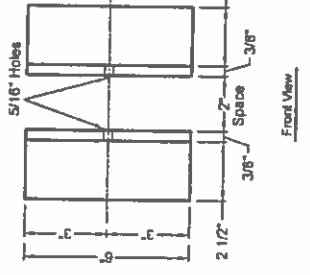
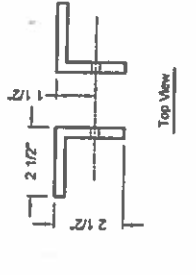
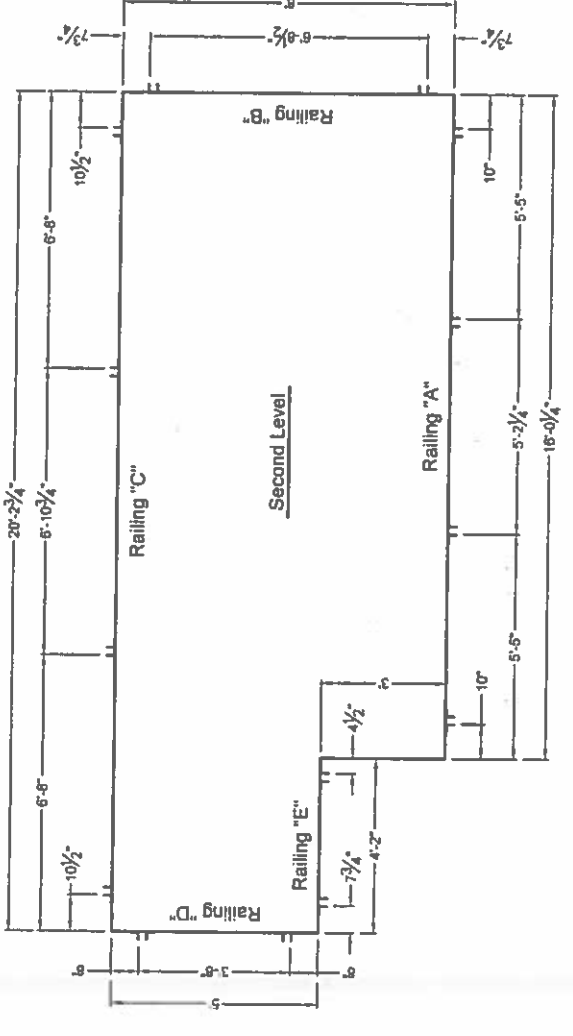

RAIL BRACKET DETAILS

CONNECTORS DETAILS

KENTUCKY FIRE COMMISSION
118 James Court
Lexington, Kentucky 40505

CONFINED SPACE PROP

SECOND LEVEL RAILINGS

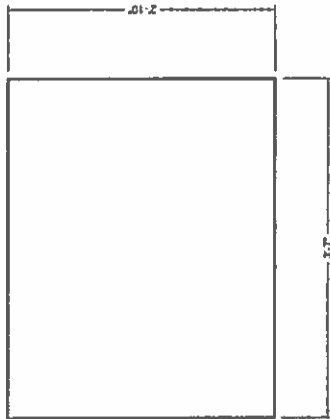

TOP VIEW

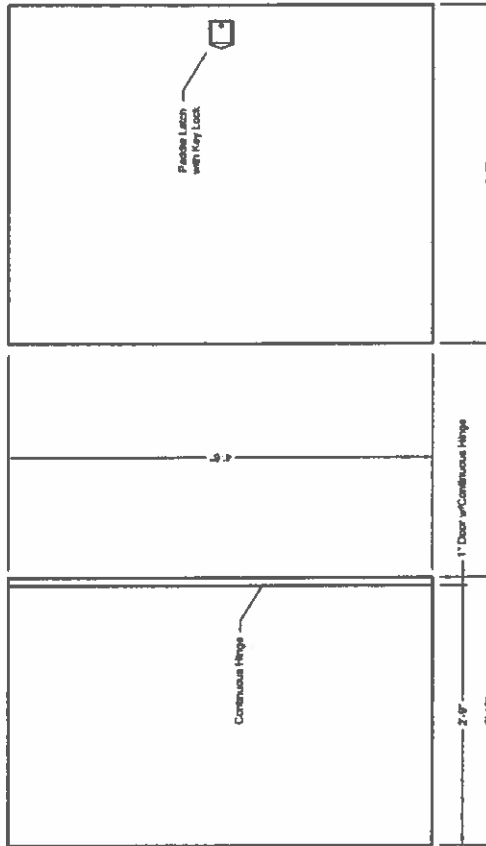

FRONT VIEW

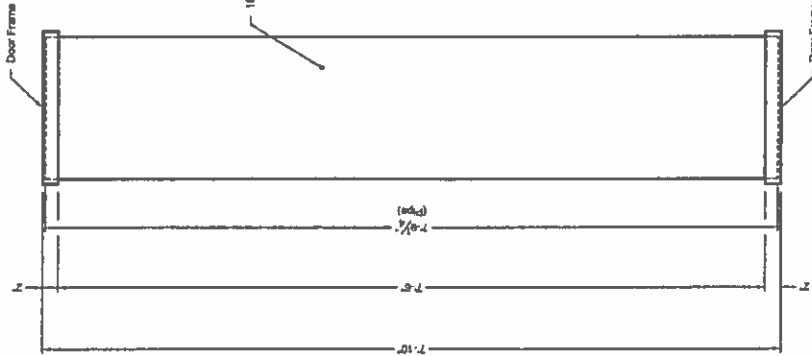

LEFT VIEW

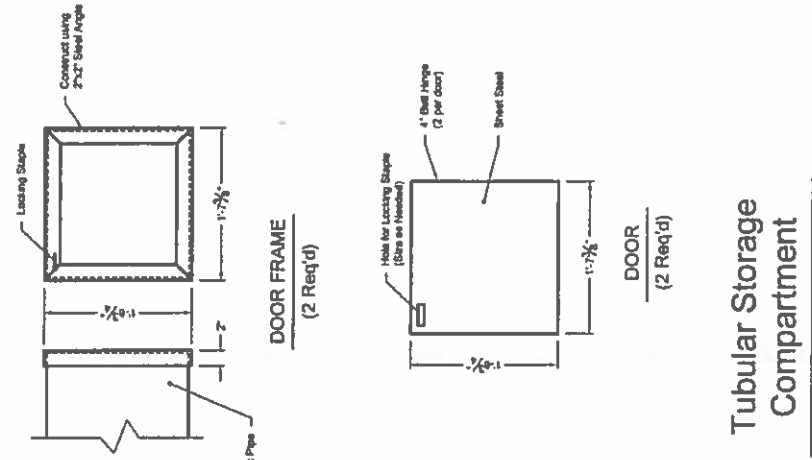

Tubular Storage Compartment

Custom Cabinet
(Left-Swinging Door)

NOTES

1. Custom Cabinets to be constructed using Aluminum Treadplate on the Box and Aluminum Sheet on the Doors.
2. Two Custom Cabinets Required: One with Left-Swinging Door as shown and One with Right-Swinging Door.
3. Cabinets shall have a Continuous Hinge on the Door.
4. Cabinets shall have a Paddle Latch with Key Locking Mechanism.
5. Tubular Storage Compartment Door Frames shall be welded in place to the Outside Band of the Trailer.

KENTUCKY FIRE COMMISSION 118 James Court Lexington, Kentucky 40505	
CONFINED SPACE PROP	
DETAILS	
Date Aug. 2018	By C.H.M.
Sheet 7 of 9	

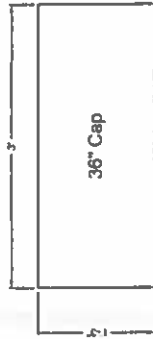
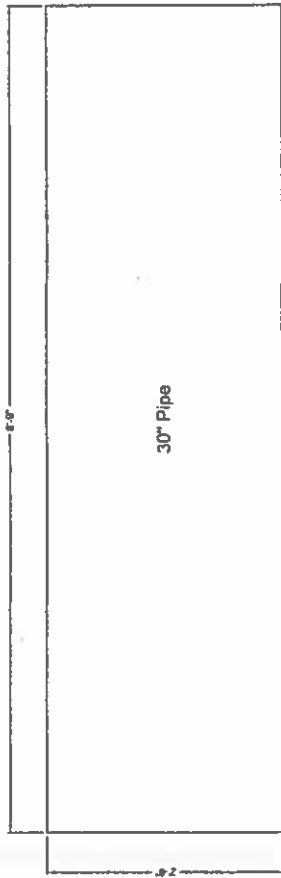
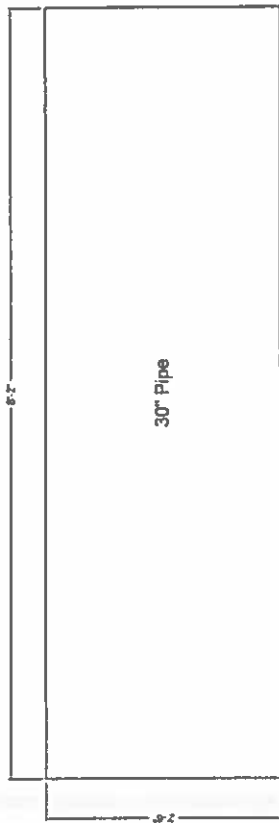

NOTE

1. Pipes shall be Corrugated Black Plastic.
2. Additional Pipes and Fittings, shown here, shall be carried on the second level while strapped down with ratchet straps.

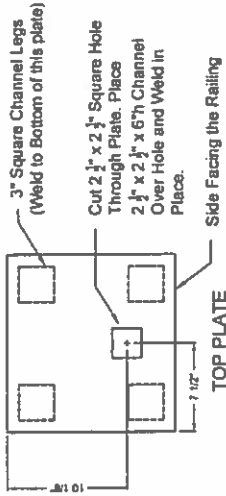
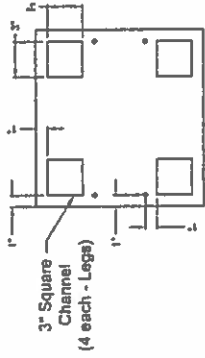

BASE PLATE

TOP PLATE

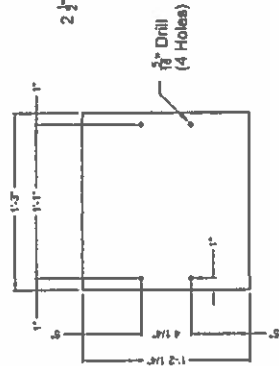

BOTTOM PLATE

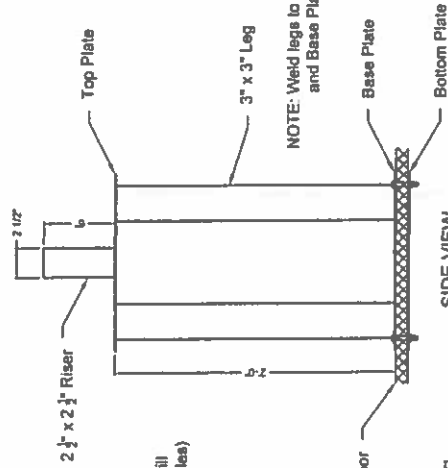

SIDE VIEW

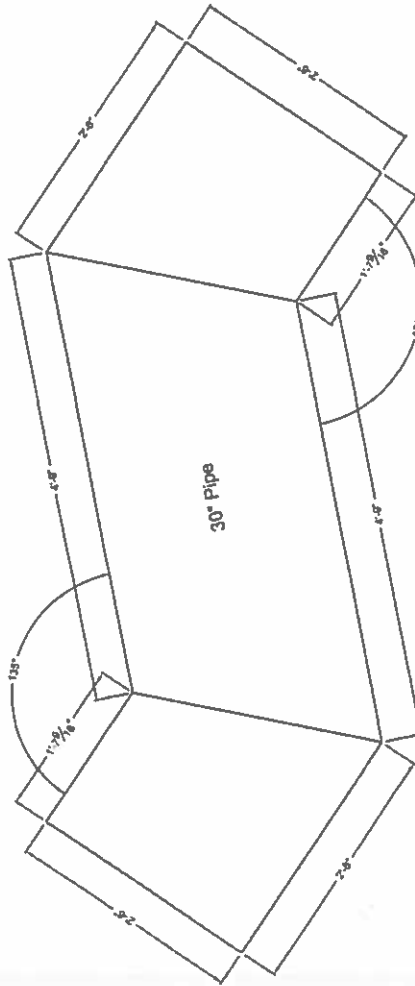
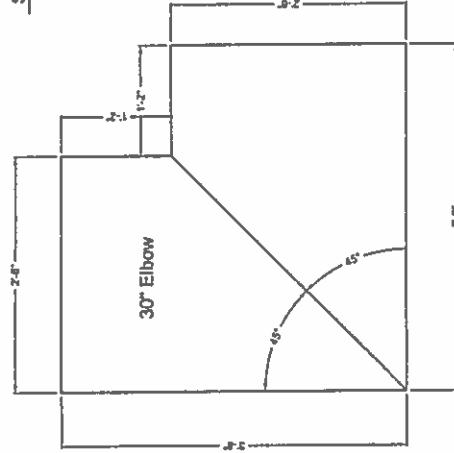

TABLE DETAILS

KENTUCKY FIRE COMMISSION 118 James Court Lexington, Kentucky 40505	
CONFINED SPACE PROP	
DETAILS	
Date Aug. 2018	Dr C.H.M.
Sheet 9 of 9	

10. Form of Proposal

ITEM	QTY	PRODUCT DESCRIPTION	PRICING	EXTENDED PRICE
1	1	Fire Rescue Trailer	\$	\$
2		Shipping	\$	\$
3		Warranty		
4		Delivery Date		

If submitting an alternate item, be sure to include all literature and diagrams.

Brand and Model offered _____

Warranty: _____

GRAND TOTAL \$ _____

11. Supplier Checklist and Substitute W-9

Supplier Bid Submission Checklist:	
Supplier is responsible for meeting all bid requirements (including those not listed below):	
YES	NO : Pg. 1 – Invitation to Bid completed & signed
YES	NO : Supplier did <u>not</u> include their own terms and conditions
YES	NO : Form of Proposal completed in its entirety – no incomplete sections
YES	NO : Substitute W-9 completed
YES	NO : Supplier meets all requirements throughout the Invitation to Bid

Substitute W-9 Form

If you are a NEW supplier with KCTCS, please register as a Supplier through the KCTCS Supplier Registration Portal so we may obtain your full contact information for ordering and payment. **Existing suppliers, be sure to attach the completed Sub W9 Form below.**

The navigation is as follows:

- Click on the following link https://systemoffice.kctcs.edu/vendor_information/index.aspx
- Select Supplier Registration Portal (left side menu)
- Follow the steps in the instructions and online
- If you are an existing supplier, please include the SubW9 form with your bid proposal

Substitute W-9 Form

Substitute W-9
Revised 12/6/13

Kentucky Community and Technical College
System 300 North Main Street, Versailles,
KY 40383

To avoid Internal Revenue Service (IRS) mandated backup withholding KCTCS is required to obtain your Taxpayer Identification Number (TIN) for reporting income paid to you or your organization. KCTCS uses a Substitute W-9 Form to obtain certification of your TIN and retains this information in its secure payee/vendor database. This form may be completed online and then printed for signature. Tab to fields and populate with your information. New Vendors must complete the entire form. Existing Vendor's may the complete shaded area of form. New and updated forms must be signed and dated.

New Vendor (complete entire form) **Changes to existing vendor**

TIN/EIN SSN

Federal Tax ID #: (Required) _____

Legal Name used for purposes of IRS reporting _____

Business Name (if different from name used for purposes of IRS reporting) _____

Does your business accept credit Cards? Yes No If yes, Visa MC Other: _____

Type of Business (Required):

- Corporation
- Partnership
- Non Profit/501(c) Entity
- Exempt from backup withholding
- Government Entity
- Foreign Entity (other than individual)
- U.S. Agent of Foreign Person/Entity
- Foreign Nonresident Individual
- Limited Liability Company
- Individual/Sole Proprietor (US Citizen)

Other (Please Explain) _____

Business Classification (Required - Select only one – Does not apply to publically traded entities)

<input type="radio"/> Minority Business Enterprise/MBE (please choose one sub-classification at right): <i>Defined as a business at least 51% owned by one or more African-Americans, Hispanics, Native Americans, Asian Pacific Americans, Asian Indian Americans, and other groups as defined by Federal law.</i>	<input type="radio"/> <i>Hispanic-American</i>	<input type="radio"/> <i>African-American</i>
	<input type="radio"/> <i>Asian-American</i>	<input type="radio"/> <i>American Indian</i>
	<input type="radio"/> <i>Other (explain):</i>	
<input type="radio"/> Women-Owned Business Enterprise/WBE <i>Defined as a business at least 51% owned by one or more women.</i>	<input type="radio"/> Disadvantaged Business Enterprise/DBE <i>Defined as a business at least 51% owned by at least one differently-abled, socially, or economically disadvantaged individual as defined by Federal law.</i>	
<input type="radio"/> Veteran Owned Business/VOB <i>Defined as a business at least 51% owned and operated by a service veteran.</i>	<input type="radio"/> Disadvantaged Veteran Owned Business/DVOB <i>Defined as a business at least 51% owned and operated by a service veteran with a service-related disability of at least 10 percent.</i>	
<input type="radio"/> None of the Above	<input type="radio"/> Other (Explain):	

Certification

Under penalties of perjury, I certify that:

The number shown on this form is my correct taxpayer identification number (or I am waiting for a number to be issued to me), and I am not subject to backup withholding because: (a) I am exempt from backup withholding, or (b) I have not been notified by the Internal Revenue Service (IRS) that I am subject to backup withholding as a result of a failure to report all interest or dividends, or (c) the IRS has notified me that I am no longer subject to backup withholding, and I am a U.S. person (including a U.S. resident alien).

Signature of U.S. Person	Date
Printed Name:	

Purchase Order	Purchase Order Information	<input type="checkbox"/> Check if remit address is same as PO address			
Preferred Method of Receiving Purchase Orders: <input type="checkbox"/> Email <input type="checkbox"/> Fax <input type="checkbox"/> Check if there is a change to your Purchase order address					
Vendor Name (if different from above)					
Order to Address					
City		State		Zip	
Sales Contact Name		Email for PO			
Sales Contact Phone		Fax for PO			
<input type="checkbox"/> Purchase Address – Change to					
Remittance	Remittance Address as it appears on your invoice				
Vendor Name (if different from above)					
Remit to Address					
City		State		Zip	
Remit to Contact Name		Email			
Remit to Phone		Fax			
<input type="checkbox"/> Remit to Address – Change to					

Wherever possible we desire to replace check payments with an electronic payment (ACH - direct deposit transfer). In order to switch your payment type if already established from paper check to electronic transfer we will need your bank account information entered on this substitute W-9 form. Your email address will only be used to notify you when an electronic payment is issued, to notify you of the issuance of a purchase order, or to notify you of other official business correspondence. Your e-mail and/or banking information will not be shared or distributed outside KCTCS' Business Services Division and will be used solely for KCTCS business applications.

Direct Deposit Information (All fields are required to receive ACH electronic direct deposit payments)	
Name on Bank Account:	
Bank Name (include branch name if applicable):	
Bank Routing Number (9-digit ABA #):	Bank Account Number:
Mark only one (should match information noted above): <input type="checkbox"/> Checking: <input type="checkbox"/> Savings:	
E-mail address -- Please print LEGIBLY -- Required for electronic notification of payment to your bank account.	
Mark if this is a: <input type="checkbox"/> Establishment of a new direct deposit <input type="checkbox"/> Change of existing direct deposit	
Email change only <input type="checkbox"/> New email address to where payment notification to be sent:	

I hereby authorize and request KCTCS to initiate credit entries for payment to my account. If necessary, a debit entry may be made in accordance with National Automated Clearing House Association (NACHA) rules reversing a credit entry made in error at the financial institution named. The electronic payment data remains in effect until withdrawn by written notification to KCTCS, 300 North Main Street, Versailles, KY 40383.

PRINTED NAME

Authorized Signature

Date